

# P2P Performance and Host Independent Management Proof of Concept Demonstration

OXR Document

OXR.POC.01.1 P2P Performance and Host Independent Management  
March 2023

---

## ABSTRACT:

XR Optics are a general class of coherent optical transceivers applicable to both point-to-point optical links as well as point-to-multipoint optical networks. XR Optics also feature unique host-independent management capabilities that may be critically important in a variety of applications. The purpose of this proof-of-concept demonstration was to characterize the reach performance of XR Optics for long-haul point-to-point applications and demonstrate the host-independent management capability. The point-to-point performance was evaluated over two long-haul fiber types at distances near the error free performance limits of the optics at 400G 16QAM, and a mixed fiber type demonstration at 300G 8QAM. The optics performed error free and the OSNR margin indicates that the distances were near the limits of the optics.

The host-independent management capability of the XR optic was successfully demonstrated by configuration of the optic via the host device interface and accessing the advanced features of the Open XR optic through an engineering utility direct to an IP interface on the optic.

The Open XR Optics Forum  
[www.openxropticsforum.org](http://www.openxropticsforum.org)

---

## Open XR Optics Forum

The Open XR Optics Forum is the multi-source agreement (MSA) working group for XR optics, the industry's first point-to-multipoint coherent pluggable transceiver technology. The Open XR Optics Forum's mission is to foster collaboration that will advance development of XR optics-enabled products and services, accelerate adoption of intelligent coherent transceivers, point-to-multipoint coherent optical network architectures, and drive standardization of networking interfaces to ensure ease of multi-vendor interoperability and an open, multi-source solution ecosystem.

For additional information contact:

Open XR Optics Forum  
[www.openxropticsforum.org](http://www.openxropticsforum.org)

**Notice:** This white paper has been created to assist The Open XR Optics Forum. The document is offered as a basis for discussion and communication, both within and outside of The Open XR Optics Forum. The Open XR Optics Forum, reserves the rights to at any time add, amend, or withdraw statements contained herein. Nothing in this document is in any way binding on The Open XR Optics Forum or any of its members.

**Permissions:** You are authorized to download, reproduce, and distribute this document. All other rights are reserved. The provision of this document should not be construed as the granting of any right to practice, make, use, or otherwise develop products that are based on the document. Any and all IP rights related to this document and the designs disclosed within, except for the rights expressly mentioned above, are reserved by the respective owners of those IP rights.

---

**Revision history:**

Version	Author	Date	Description
V1.0	Brad Lester Brenda Chavez Morgan Pofahl Mary Hughson Ben Foo John van Weerdenburg Aaron Chase	March 03, 2023	Date of initial publication
V1.1	Phillip Amaya	October 10,2023	Change name from Open XR Forum to Open XR Optics Forum

**SOURCE:**

**Editors:**

Morgan Pofahl  
 Company: Lumen Technologies  
 Address: 100 CenturyLink Drive, Monroe, LA 71203  
 Email: [Morgan.pofahl@lumen.com](mailto:Morgan.pofahl@lumen.com)

Aaron Chase  
 Company: Infinera  
 Address: 6376 San Ignaciao Avenue, San Jose, CA 95119  
 Email: [Achase@infinera.com](mailto:Achase@infinera.com)

## CONTENTS

1	Executive Summary.....	6
1.1	Point-to-Point Reach Performance.....	6
1.2	Host Independent Management (Dual Management) .....	6
2	Objectives of the Proof-of-Concept.....	6
2.1	Objectives Overview .....	6
2.2	Point-to-Point Reach Performance.....	6
2.3	Host Independent Management (Dual Management) <sup>6</sup> .....	7
3	Demonstration .....	9
3.1	Point-to-Point Reach Performance.....	9
3.1.1	SMF-ULL Reach Performance .....	9
3.1.2	LEAF Reach Performance.....	12
3.1.3	8QAM SMF-ULL+LEAF Reach Performance.....	13
3.2	Dual Management.....	14
4	Conclusion .....	14
5	References .....	15
6	APPENDIX 1.....	16

## LIST OF TABLES

Table 1:	SMF-ULL Demo Results.....	10
Table 2:	LEAF Demo Results .....	12
Table 3:	SMF-ULL+LEAF Demo Results.....	13

## LIST OF FIGURES

Figure 1	Module Management .....	8
Figure 2	DWDM Line System .....	9
Figure 3:	SMF-ULL Host Layout .....	10
Figure 4:	XR Per-Subcarrier 16QAM Constellation Diagram.....	11
Figure 5:	SMF-ULL XR at 191.950THz with aggressors Colorless A/D .....	11
Figure 6:	SMF-ULL XR at 191.950THz with aggressors FOADM .....	11
Figure 7:	LEAF Host Layout.....	12
Figure 8:	SMF-ULL+LEAF Host Layout .....	13
Figure 9:	XR Per-Subcarrier 8QAM Constellation Diagram .....	14
Figure 10:	SMF-ULL XR at 191.950THz with aggressors Colorless A/D Spectrum and Per-Subcarrier 16 QAM Constellation Diagram.....	16

Figure 11: SMF-ULL XR at 191.950THz with aggressors FOADM Spectrum and Per-Subcarrier 16 QAM Constellation Diagram.....17

Figure 12: SMF-ULL XR at 193.525THz with aggressors Colorless A/D Spectrum and Per-Subcarrier 16 QAM Constellation Diagram.....17

Figure 13: SMF-ULL XR at 193.525THz with aggressors FOADM Spectrum and Per-Subcarrier 16 QAM Constellation Diagram.....18

Figure 14: SMF-ULL XR at 195.100THz with aggressors Colorless A/D Spectrum and Per-Subcarrier 16 QAM Constellation Diagram.....18

Figure 15: SMF-ULL XR at 195.100THz with aggressors FOADM Spectrum and Per-Subcarrier 16 QAM Constellation Diagram.....19

Figure 16: LEAF XR at 191.950THz with aggressors Colorless A/D Spectrum and Per-Subcarrier 16 QAM Constellation Diagram.....19

Figure 17: LEAF XR at 191.950THz with aggressors FOADM Spectrum and Per-Subcarrier 16 QAM Constellation Diagram.....20

Figure 18: LEAF XR at 193.525THz with aggressors Colorless A/D Spectrum and Per-Subcarrier 16 QAM Constellation Diagram.....20

Figure 19: LEAF XR at 193.525THz with aggressors FOADM Spectrum and Per-Subcarrier 16 QAM Constellation Diagram.....21

Figure 20: LEAF XR at 195.100THz with aggressors Colorless A/D Spectrum and Per-Subcarrier 16 QAM Constellation Diagram.....21

Figure 21: LEAF XR at 195.100THz with aggressors FOADM Spectrum and Per-Subcarrier 16 QAM Constellation Diagram.....22

Figure 22: SMF-ULL+LEAF XR at 191.425THz with aggressors FOADM Spectrum and Per-Subcarrier 16 QAM Constellation Diagram.....22

Figure 23: SMF-ULL+LEAF XR at 191.950THz with aggressors FOADM Spectrum and Per-Subcarrier 16 QAM Constellation Diagram.....23

Figure 24: SMF-ULL+LEAF XR at 193.525THz with aggressors FOADM Spectrum and Per-Subcarrier 16 QAM Constellation Diagram.....23

Figure 25: SMF-ULL+LEAF XR at 195.100THz with aggressors FOADM Spectrum and Per-Subcarrier 16 QAM Constellation Diagram.....24

## 1 Executive Summary

The Open XR Optics Forum is developing interface requirements and specifications for a new class of software configurable pluggable transceivers for use in point-to-point and point-to-multipoint coherent optical networks. In support of these objectives a proof-of-concept demonstration was undertaken to evaluate the long reach, point-to-point performance of XR optic pluggable transceivers utilizing Digital Subcarrier Modulation (DSCM) and incorporating an advanced, host-independent, management method.<sup>1</sup> Long reach performance was demonstrated over two different amplified line systems at distances near the error performance limits of the transceivers. The host-independent management capability of the XR optic was successfully demonstrated by configuration of the optic via the host device interface and advanced features of the transceiver were accessed through an engineering utility direct to an IP interface on the optic.

### 1.1 Point-to-Point Reach Performance

XR optics were demonstrated to provide error free performance at modeled distances within a 3<sup>rd</sup> party host device, over a 3<sup>rd</sup> party line system with different fiber types and modulations as shown below:

1435km of Corning® SMF-ULL fiber at 400G 16QAM modulation.

1060km of LEAF fiber at 400G 16QAM modulation.

The XR optic was also error free at most wavelengths when the SMF-ULL and LEAF line systems were combined for 2495km of fiber at 300G 8QAM modulation. Point-to-point optimized; QSFP56-DD XR optics were used in all test cases presented herein.

### 1.2 Host Independent Management (Dual Management)

Throughout the point-to-point reach demonstration, the host device (router) user interface was used to configure the basic parameters of the XR optic pluggable transceiver. In addition to this interface, a direct interface which was host independent was used by an engineering software application tool to capture signal and spectral information from the XR optic. Using both methods of interfacing with the XR optic demonstrated the dual management capabilities of the pluggable.

## 2 Objectives of the Proof-of-Concept

### 2.1 Objectives Overview

This proof-of-concept aims to demonstrate that XR optic pluggable transceivers can serve as drop-in replacements of currently available pluggable coherent transceivers while offering additional flexibility and advanced management capabilities. The objectives are therefore two-fold:

- Demonstrate and validate the reach modeling of XR optics in a DWDM line system with significant reach.
- Demonstrate the advanced host independent (dual management) capabilities in third party host systems.

### 2.2 Point-to-Point Reach Performance

Point-to-point connections represent a broad category of applications for XR optics. The modeling of reach for XR optics indicates that performance over long-distance links should meet or exceed the current state-of-

the art for commercially available pluggable coherent transceivers.<sup>2</sup> XR Optics utilize Digital Subcarrier Modulation (DSCM) to transmit coherent optical signals. Important benefits of using DSCM are enhanced tolerance to linear and non-linear impairments, which can offset implementation penalties associated with higher transmission rates over long distances and optical filtering in cascaded ROADMs.<sup>3-5</sup> An objective of this demonstration is to operate the XR optics over a DWDM line system that has enough fiber distance to validate the reach modeling of the XR optic.

Pluggable coherent optics are attractive for router integration since they can be connected directly to a DWDM line system or over dark fiber thus eliminating additional equipment and cost for a muxponder/transponder. The most recent generation of coherent pluggable transceivers feature 400G transmission data rates over metro and regional distances with even longer distances at reduced transmission rates. Specifications for optics used in these applications have been published as part of Multi-Source Agreements (MSAs). A unique benefit of XR optics is the capability to close longer reach links in these applications, plugging directly into routers, while providing host independent management that delineates IP and Transport management functions.

### 2.3 Host Independent Management (Dual Management)<sup>6</sup>

The features and capabilities of pluggable optics are advancing at a rapid pace along with the diversity of applications and related hosting devices. These advancements are constrained by the management architecture in place today and these constraints limit its effectiveness moving forward. The working assumption for the last few decades has been that the host device is performing all advanced features and that the pluggable optics within the host device are simply static bandwidth pipes. There are a few exceptions to this rule but in general, access to any advanced features within a pluggable module are very host device dependent and not generally available across different host device types or from host devices supplied by different network equipment manufacturers.

There are 3 primary challenges to be addressed as coherent pluggable optics are deployed in an ever-wider range of network applications, 1) pluggable optics will continue to have more advanced features and capabilities over time, 2) the host devices that coherent modules plug into will expand, and 3) the network management architecture needs to be minimally impacted. There is also a widespread desire by many network operators to maintain as much disaggregation as possible. Today most coherent optics have limited provisioning modes and do little more than provide a fixed bandwidth pipe. The next generation of pluggable optics will have probabilistic shaping, which can enable a multitude of different modulation rate and baud rate combinations for different capacity at different reach with different spectral consumption. In addition to the basic transport functions there are also features such as remote module discovery, awareness and management enabled via communication channels, as well as point-to-multipoint operation, integrated Layer 2 functions, Layer 1 encryption, and advanced telemetry functions. The host device for coherent modules started with transport devices as a DCO optic and has recently been expanding into Layer 2/3 switches and routers. Development is also underway to expand the use of coherent optics even further into servers for edge compute applications, radio units for beyond 5G and 6G applications, and OLT devices for fiber to the edge applications.

In the current structure of the network management architecture most network providers have 3 primary domain controllers, one for the Transport domain managing L0 – L1, one for the IP domain managing L2-L3, and one for the Application Domain managing L4+. To minimize the impact on the network management

architecture while also maintaining a disaggregated network model the management of the coherent optics need to be managed within the Transport domain. Additionally, as pluggable module features and capabilities continue to grow, network providers would prefer an architecture model where the management interface to the pluggable optic is common across all potential devices. It is also important to consider where feature development takes place. If every host device has to fully integrate the expanding functional capabilities of each optic used, it will divert the engineering resources available for host development from their given areas of expertise or require more engineering resources from the host developer. Forcing a model that requires full cross layer understanding and integration would inherently lead to roadmap fidelity issues and higher testing and approval cycle times with the network providers trying to validate compatibility with each new release on every platform deployed.

One easy option to solve these challenges is to use a centralized host independent management architecture. In this architecture model the host device would manage the basic SERDES based features. Other transport parameters and features that the host device supports can optionally be managed via the host device when and where it makes sense operationally. The user also has the option to manage the additional parameters and features directly, along with any features that the host device is unaware of, using a separate software application that communicates directly to the modules. This enables a centralized management interface into all the pluggable optics regardless of which host device they are plugged into and removes the need for the host device to self-certify each new application on each new module type. This direct centralized management architecture for pluggable modules would mirror that of most optical networks today.

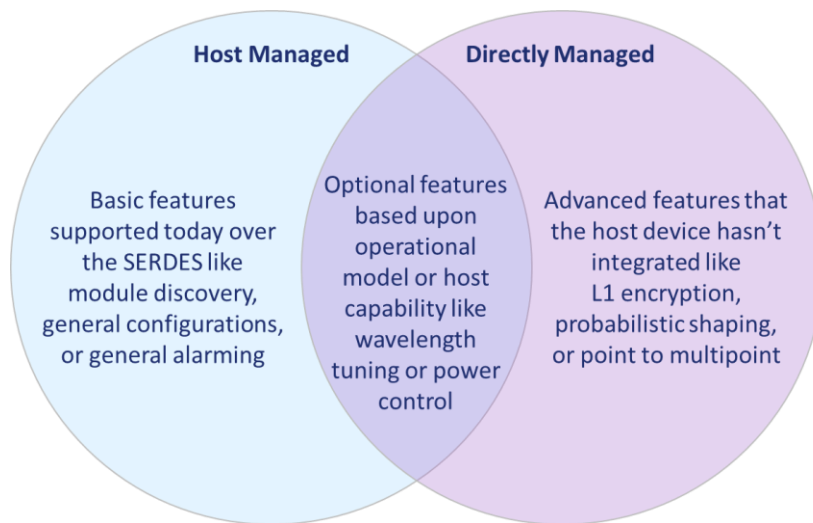

Figure 1 Module Management

In this PoC test we will demonstrate the ability to support a host independent management channel and communication directly to the modules with a separate software application.



### 3 Demonstration

#### 3.1 Point-to-Point Reach Performance

The XR optics used in the testing for each of the use cases are the QSFP56-DD module type, optimized for point-to-point performance. The testing was performed on a laboratory DWDM line system constructed to mimic the conditions of a typical production environment. The DWDM line system consisting of 14 spans of long-haul fiber was utilized (Figure 2) for the reach performance demonstration. The amplifiers on the line system are EDFA-Raman hybrids. WSS-based Dynamic Gain Equalizers (DGEs) were employed after the 5th and 9th spans. The terminals included twin 1:12 WSS ROADMs with two add/drop structures: a six-channel colorless passive mux/demux and a 64-channel fixed add/drop multiplexer (FOADM) at 75GHz spacing. Anchor waves were present to prevent line system from shutting down during transitions from one test case to another.

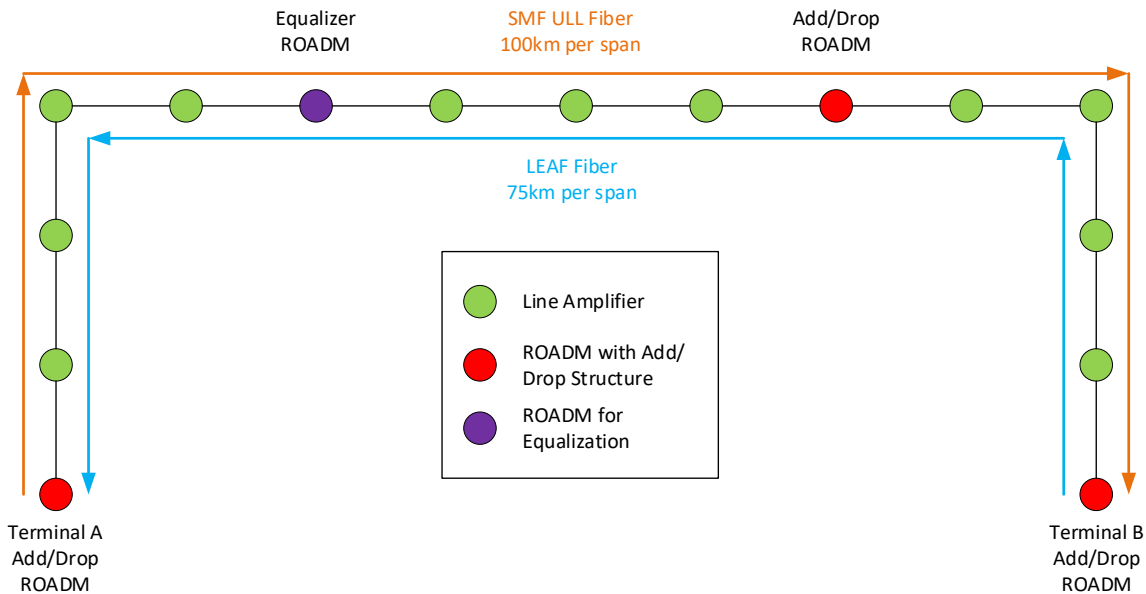

Figure 2 DWDM Line System

Optical launch power into the fiber was consistent with typical values found in coherent transponder-based ROADM production networks. Three center frequencies were selected to capture the performance of the XR optics in the low, mid, and high portions of the C-Band spectrum. Each frequency was established through the six-channel colorless mux/demux at each terminal and through the 64-channel FOADM at each terminal.

##### 3.1.1 SMF-ULL Reach Performance

SMF-ULL is a fiber type used for long-haul DWDM; the fiber in the test bed complied with ITU-T Recommendation G.652.B and G.654.C. Each of the 14 spans were approximately 100km for a total distance of 1435km, with a total chromatic dispersion of almost 25,000 ps/nm . The demonstration was unidirectional between the host devices which contained the XR optics as show in Figure 3.

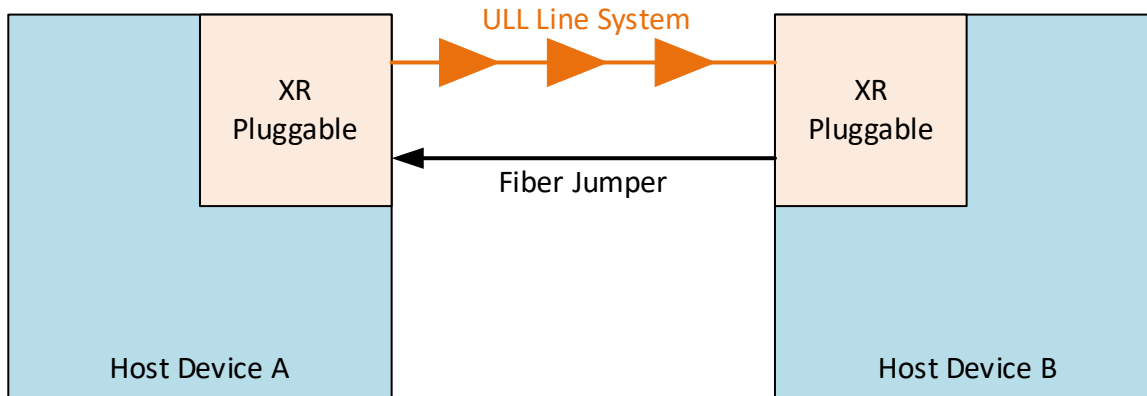

Figure 3: SMF-ULL Host Layout

Modeling indicated that the XR optic would perform error free on this line system at 400G 16QAM modulation. Wavelengths were assigned based on a 75GHz channel plan (center to center spacing). Aggressor coherent carriers were present on adjacent channels above and below at each frequency tested. Additional carriers of both Multiple Sub-Carriers (XR modules) and single carriers (ZR+ modules) were also present on the line system. Two additional XR modules were used for aggressor wavelengths, and were spaced at 75GHz on both sides of the XR optic under test for each frequency demonstrated. Performance was validated using an ethernet test set monitoring for errors of generated test traffic between the host devices through the XR optics. OSNR margin was recorded and confirmed the performance of the XR optic was at or near the threshold for uncorrectable errors.

XR Frequency (THz)	Add/Drop Structure	OSNR Margin (dB)	Test Traffic Error Free?
191.950	Colorless	0.0	Yes
	FOADM	0.0	Yes
193.525	Colorless	0.5	Yes
	FOADM	0.6	Yes
195.100	Colorless	0.2	Yes
	FOADM	0.2	Yes

Table 1: SMF-ULL Demo Results

The following figures depict XR optic's constellation pattern and spectral shaping at the optic's receiver. The data was captured through the direct connection to the optic and presented via an engineering software application.

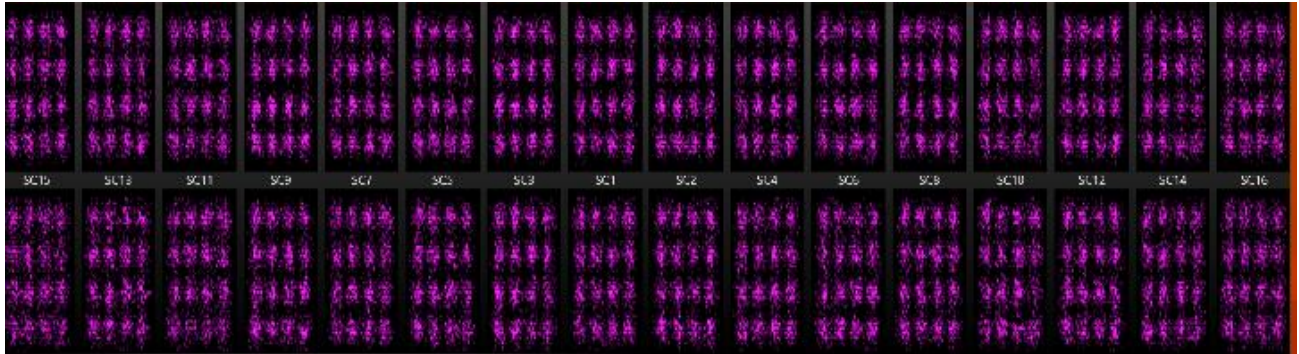

Figure 4: XR Per-Subcarrier 16QAM Constellation Diagram

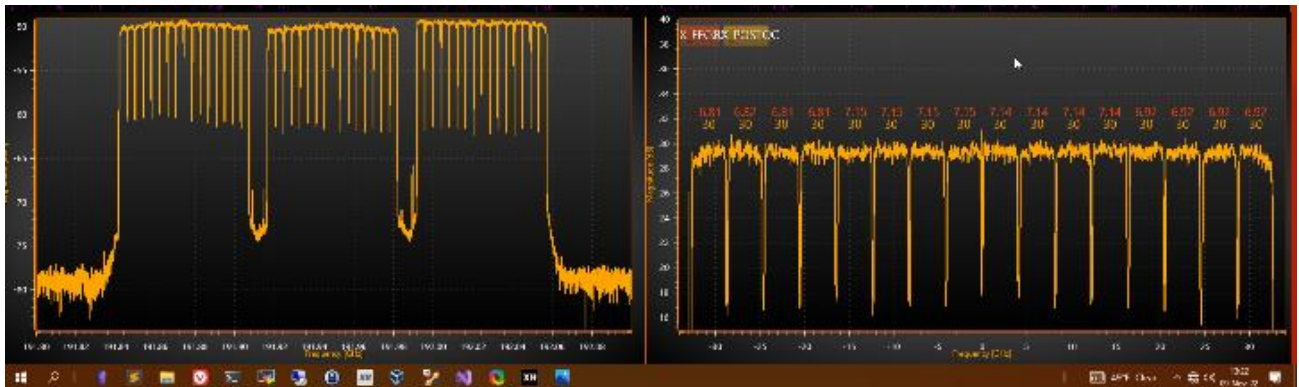

Figure 5: SMF-ULL XR at 191.950THz with aggressors Colorless A/D

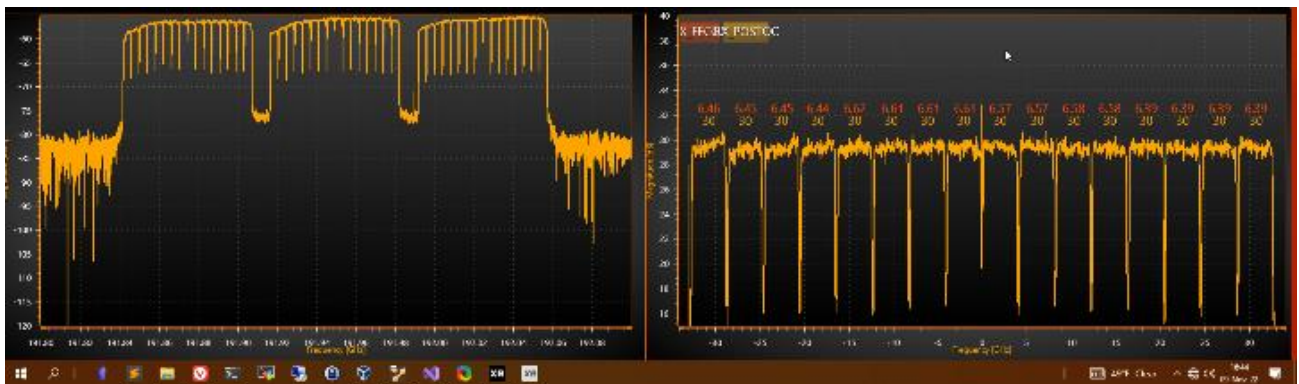

Figure 6: SMF-ULL XR at 191.950THz with aggressors FOADM

### 3.1.2 LEAF Reach Performance

LEAF is a fiber type used for long-haul DWDM; the fiber in the test bed complied with ITU-T Recommendation G.655.D. Each of the 14 spans were approximately 75km for a total distance of 1060km, with a total chromatic dispersion of approximately 4,400 ps/nm. The demonstration was unidirectional between the host devices which contained the XR optics as show in **Error! Reference source not found..**

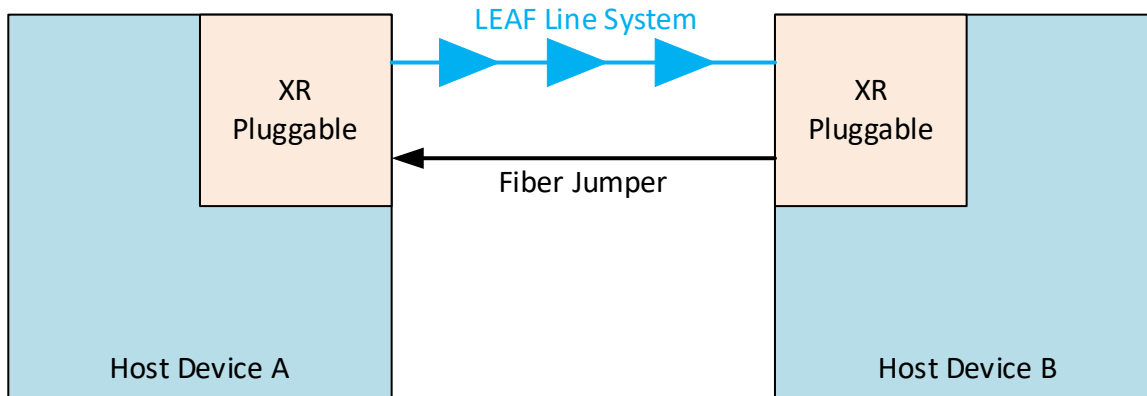

Figure 7: LEAF Host Layout

Modeling indicated that the XR optic would perform error free on this line system at 400G 16QAM modulation. Wavelengths were assigned based on 75GHz channel plan (center to center spacing). Aggressor coherent carriers were present on adjacent channels above and below at each frequency tested. Additional carriers of both Multiple Sub-Carriers (XR modules) and single carriers (ZR+ modules) were also present on the line system. Two additional XR modules were used for aggressor wavelengths, and were spaced at 75GHz on both sides of the XR optic under test for each frequency demonstrated. Performance was validated using an ethernet test set monitoring for errors of generated test traffic between the host devices through the XR optics. OSNR margin was recorded and validated the performance of the XR optic was at or near the threshold for uncorrectable errors.

XR Frequency (THz)	Add/Drop Structure	OSNR Margin (dB)	Test Traffic Error Free?
191.950	Colorless	0.6	Yes
	FOADM	0.1	Yes
193.525	Colorless	0.3	Yes
	FOADM	0.6	Yes
195.100	Colorless	0.1	Yes
	FOADM	0.1	Yes

Table 2: LEAF Demo Results

### 3.1.3 8QAM SMF-ULL+LEAF Reach Performance

The final reach performance objective was to demonstrate 300G 8QAM modulation across a line system that would not operate error free at 400G 16QAM modulation. The 14 span SMF-ULL and 14 span LEAF line systems were used for a combined total of 2495km (1435km SMF-ULL + 1060km Leaf previously tested over), with a total chromatic dispersion of approximately 29,400 ps/nm. The 64-channel FOADM was the only add/drop structure used for this demonstration because it provided channel isolation at the FOADM egress which was optically looped back to the FOADM ingress (refer to Terminal B of Figure 2). The demonstration was unidirectional between the host devices which contained the XR optics as shown in **Error! Reference source not found..**

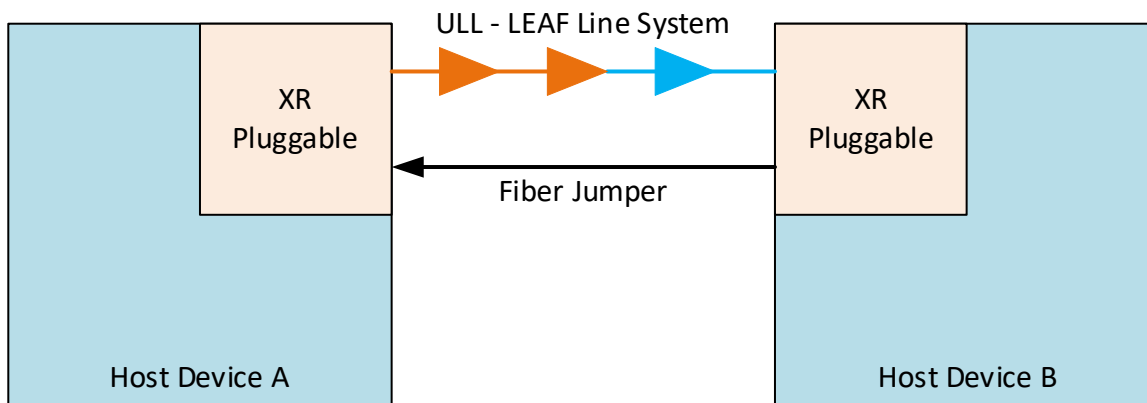

Figure 8: SMF-ULL+LEAF Host Layout

Two additional XR optics were used for aggressor wavelengths, and were spaced at 75GHz on both sides of the XR optic under test for each frequency demonstrated. Performance was validated using an ethernet test set monitoring for errors of generated test traffic between the host devices through the XR optics. OSNR margin was recorded and confirmed the performance of the XR optic was at or near the threshold for uncorrectable errors.

XR Frequency (THz)	Add/Drop Structure	OSNR Margin (dB)	Test Traffic Error Free?
191.425	FOADM	~0.3	Yes
191.950	FOADM	~0.8	Yes
193.525	FOADM	~0.1	Yes
195.100	FOADM	~0.1	Yes
195.625	FOADM	~0.1	No

Table 3: SMF-ULL+LEAF Demo Results

The following figures depict XR optic’s constellation pattern and spectral shaping at the optic’s receiver. The data was captured through the direct connection to the optic and presented via an engineering software application.



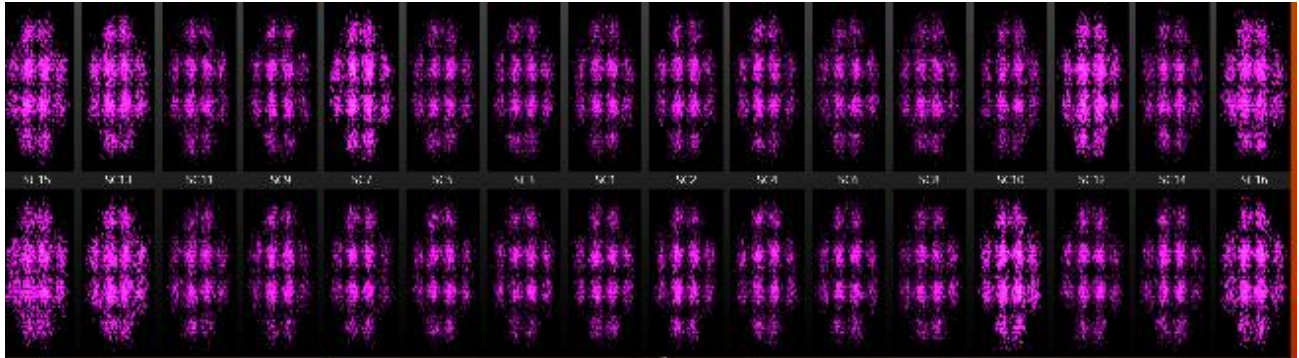

Figure 9: XR Per-Subcarrier 8QAM Constellation Diagram

### 3.2 Dual Management

During the testing in the lab the XR Modules had basic turn up and configuration managed via the host device for the optics. There was then a management VLAN that was established between the module and an engineering software application that was leveraged for the testing. The dual management demonstration highlights the ability to manage the optics independent of host and enable a centralized management solution. As features increase over time, or host devices expand in the architecture, the management interface remains consistent and independent. In The Open XR Optics Forum this would be equivalent to the Open XR Controller. Some of the general features that were controlled via the direct management connection were wavelength tuning and launch power control. The software application also collected real time performance and telemetry information and presented the information into several of the screen captures presented throughout this document. The application provided not only a holistic view but also a per subcarrier view and control.

## 4 Conclusion

The testing was able to validate that XR Optics can achieve very long distance transmission in a point-to-point application while operating in a 3<sup>rd</sup> party layer 3 device and transmitting over a 3<sup>rd</sup> party line system. The tests were performed with both a 75GHz fixed filter AWG Mux and a colorless mux filter with adjacent aggressor wavelengths over the 3<sup>rd</sup> party ROADM line system. At 400Gb/s XR Optics ran error free over 1435km of SMF-ULL fiber and over 1060km of Leaf fiber. At 300Gb/s the optics ran error free over the links combined, totaling 2495km with mixed fiber types.

In addition to the performance testing, the team also validated the host independent management capability of the optics. There was a management VLAN built through the 3<sup>rd</sup> party router to enable direct communication between the XR Optics modules and a software application. The software application was used to perform basic functions like wavelength tuning as well as more advanced telemetry functions, which were used to capture the performance results outlined in this paper.

## 5 References

1. D. Welch *et al.*, "Point-to-Multipoint Optical Networks Using Coherent Digital Subcarriers", in *Journal of Lightwave Technology*, vol. 39, no. 16, 5232-5247, August 15, 2021
2. Windstream (March 08, 2022), "Windstream Wholesale successfully completes 1000 km 400G ZR+ field trials", Retrieved from WINDSTREAM Holdings Website <https://news.windstream.com/news/news-details/2022/Windstream-Wholesale-successfully-completes-1000-km-400G-ZR-field-trials/default.aspx>
3. A.M. Rosa Brusin *et al.*, "Enhanced resilience towards ROADM-induced optical filtering using subcarrier multiplexing and optimized bit and power loading", in *Optics Express*, vol. 27, no.21, 30710-30725, October 14, 2019
4. Han Sun *et al.*, "800G DSP ASIC Design Using Probabilistic Shaping and Digital Sub-Carrier Multiplexing", in *Journal of Lightwave Technology*, vol. 38, no.17, 4744-4756, September 01, 2020
5. P. Poggiolini *et al.*, "Analytical and Experimental Results on System Maximum Reach Increase Through Symbol Rate Optimization," in *Journal of Lightwave Technology*, vol. 34, no. 8 1872-1885, April 15, 2016
6. Open XR Forum. (2022, March). Open XR Management Architecture Specification. Retrieved from Open XR Forum: <https://www.openxropticsforum.org/documents>.

**6 APPENDIX 1**

Capture Details of Results

The following figures depict XR optic’s constellation pattern and spectral shaping at the optic’s receiver. The data was captured through the direct connection to the optic and presented via an engineering software application.

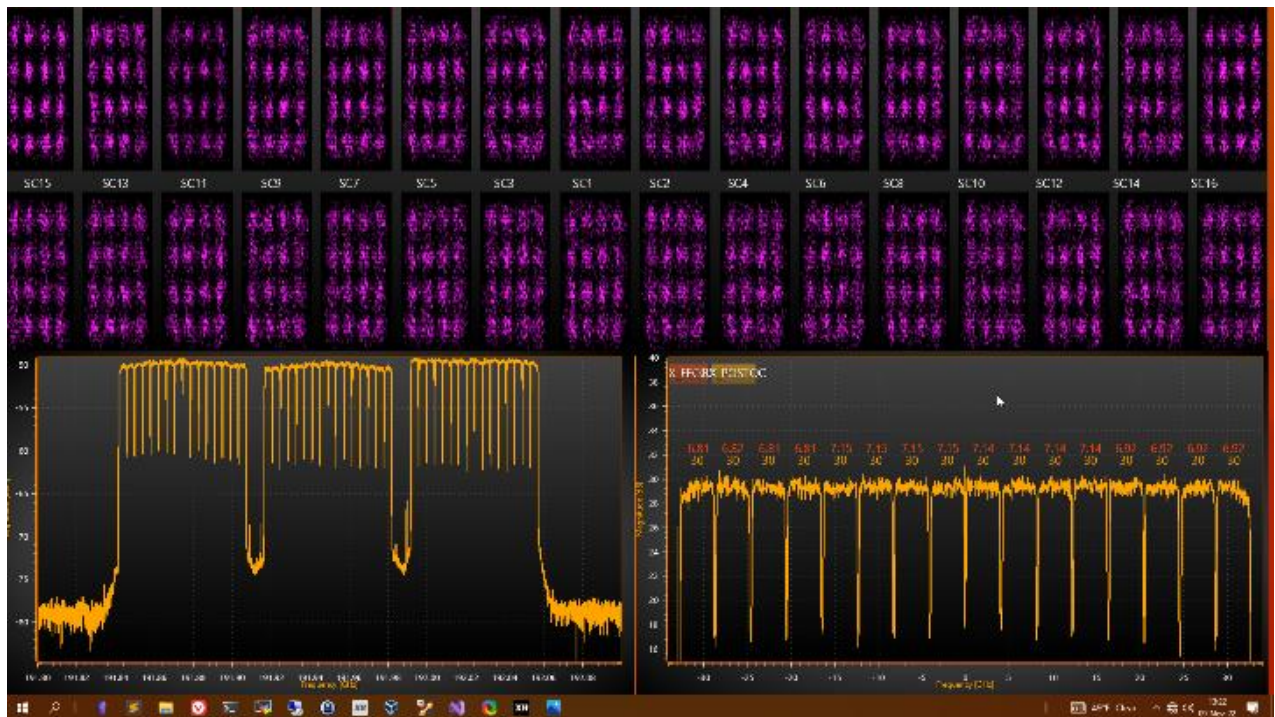

Figure 10: SMF-ULL XR at 191.950THz with aggressors Colorless A/D Spectrum and Per-Subcarrier 16 QAM Constellation Diagram



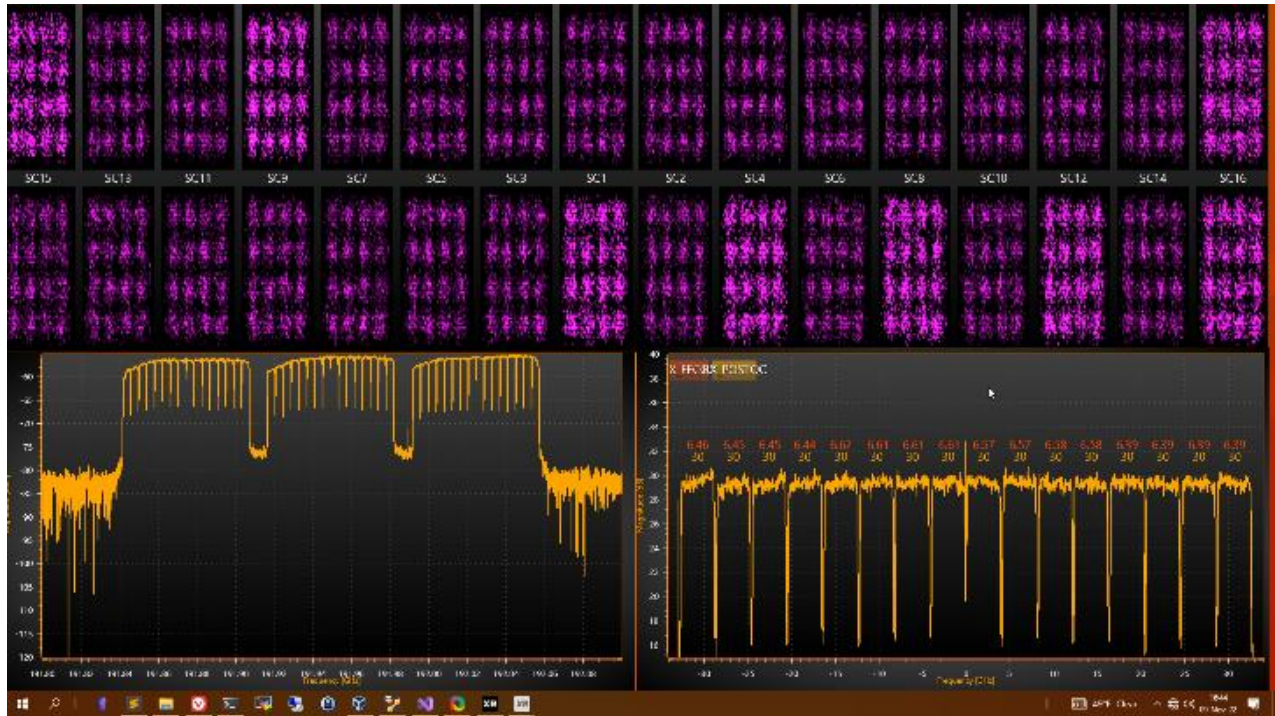

Figure 11: SMF-ULL XR at 191.950THz with aggressors FOADM Spectrum and Per-Subcarrier 16 QAM Constellation Diagram

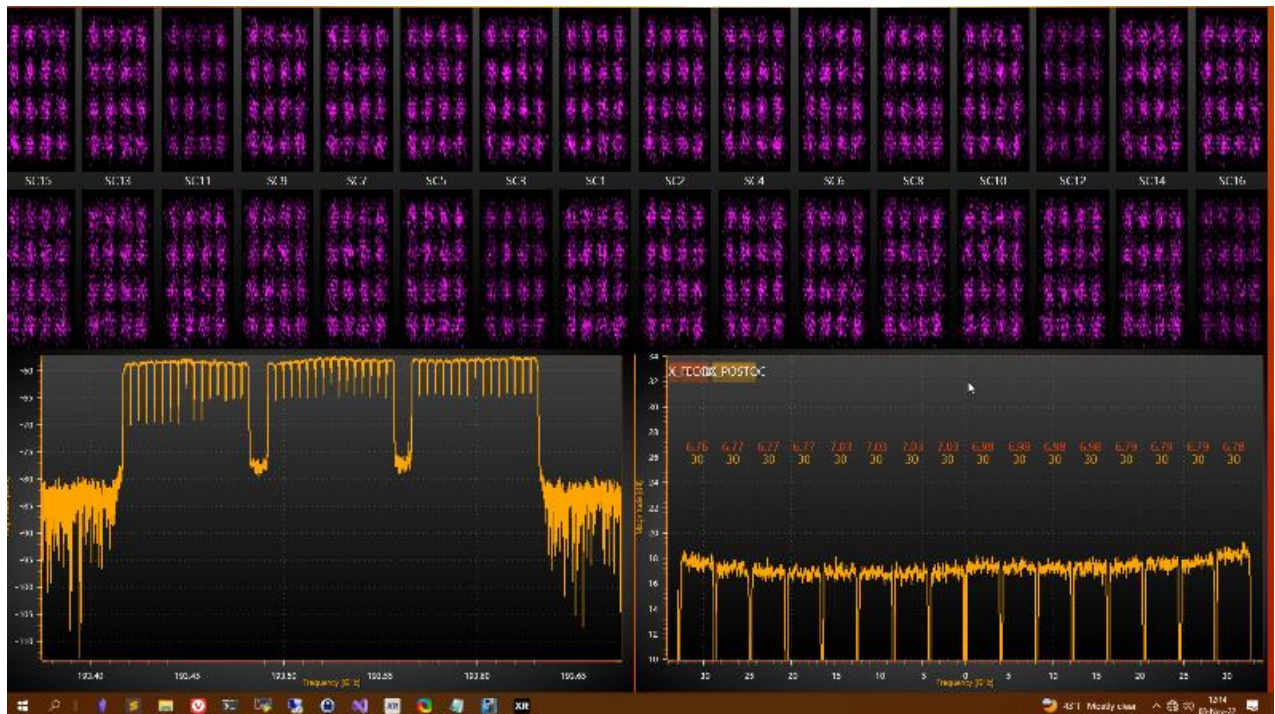

Figure 12: SMF-ULL XR at 193.525THz with aggressors Colorless A/D Spectrum and Per-Subcarrier 16 QAM Constellation Diagram



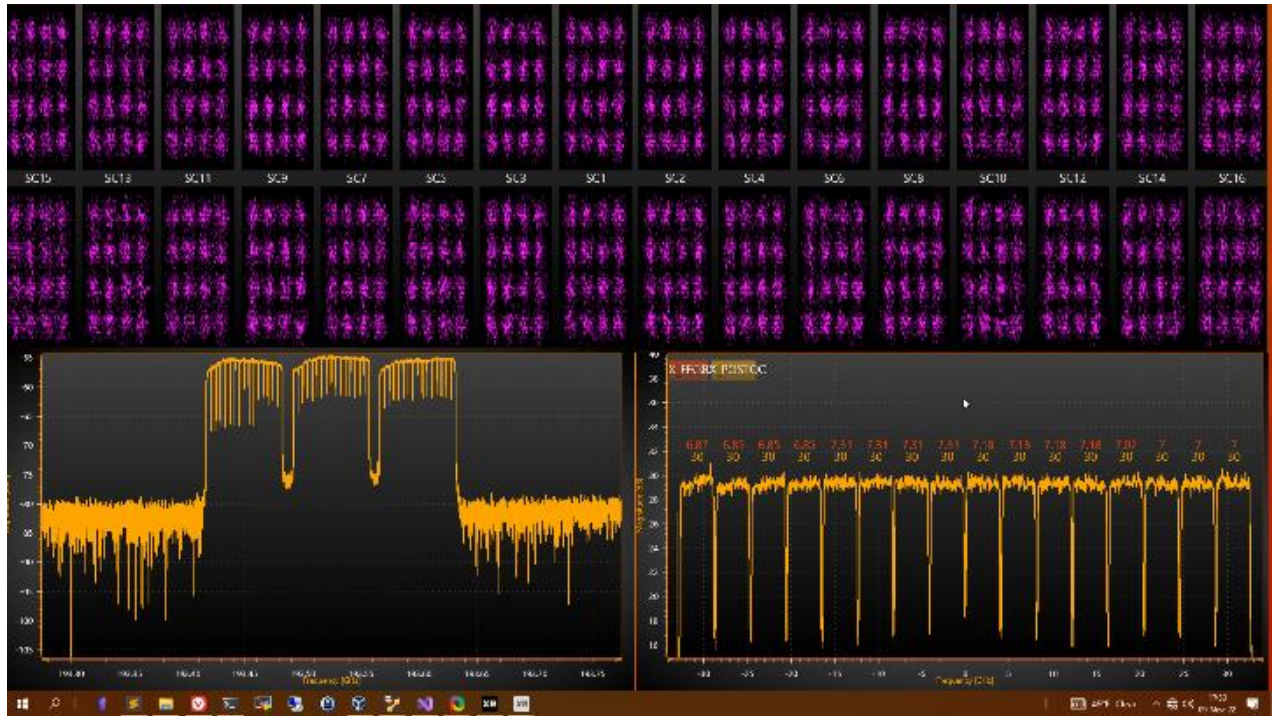

Figure 13: SMF-ULL XR at 193.525THz with aggressors FOADM Spectrum and Per-Subcarrier 16 QAM Constellation Diagram

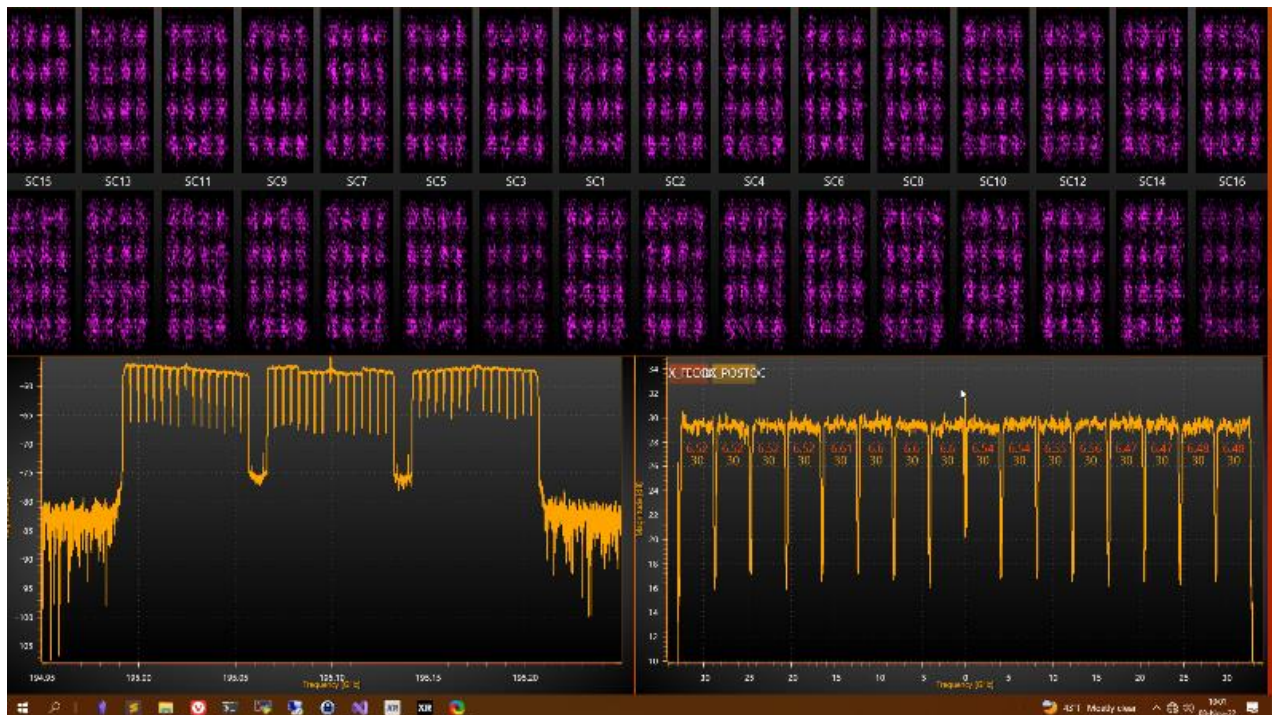

Figure 14: SMF-ULL XR at 195.100THz with aggressors Colorless A/D Spectrum and Per-Subcarrier 16 QAM Constellation Diagram



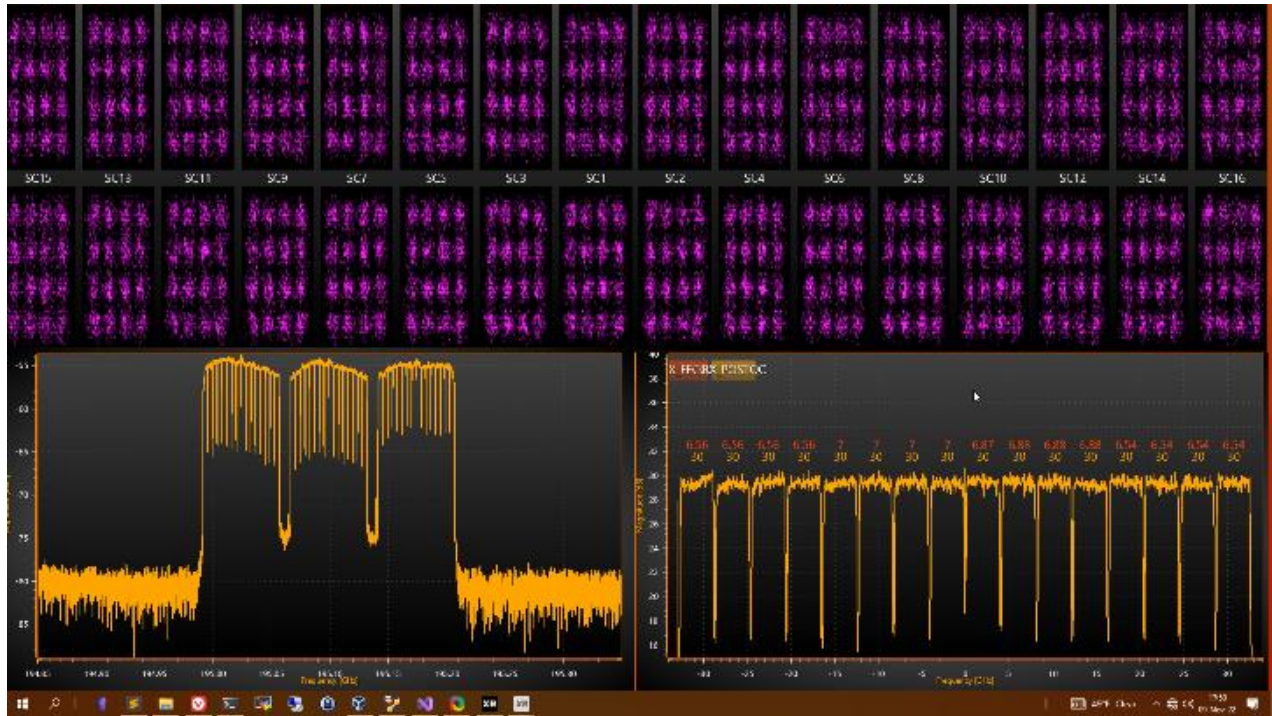

Figure 15: SMF-ULL XR at 195.100THz with aggressors FOADM Spectrum and Per-Subcarrier 16 QAM Constellation Diagram

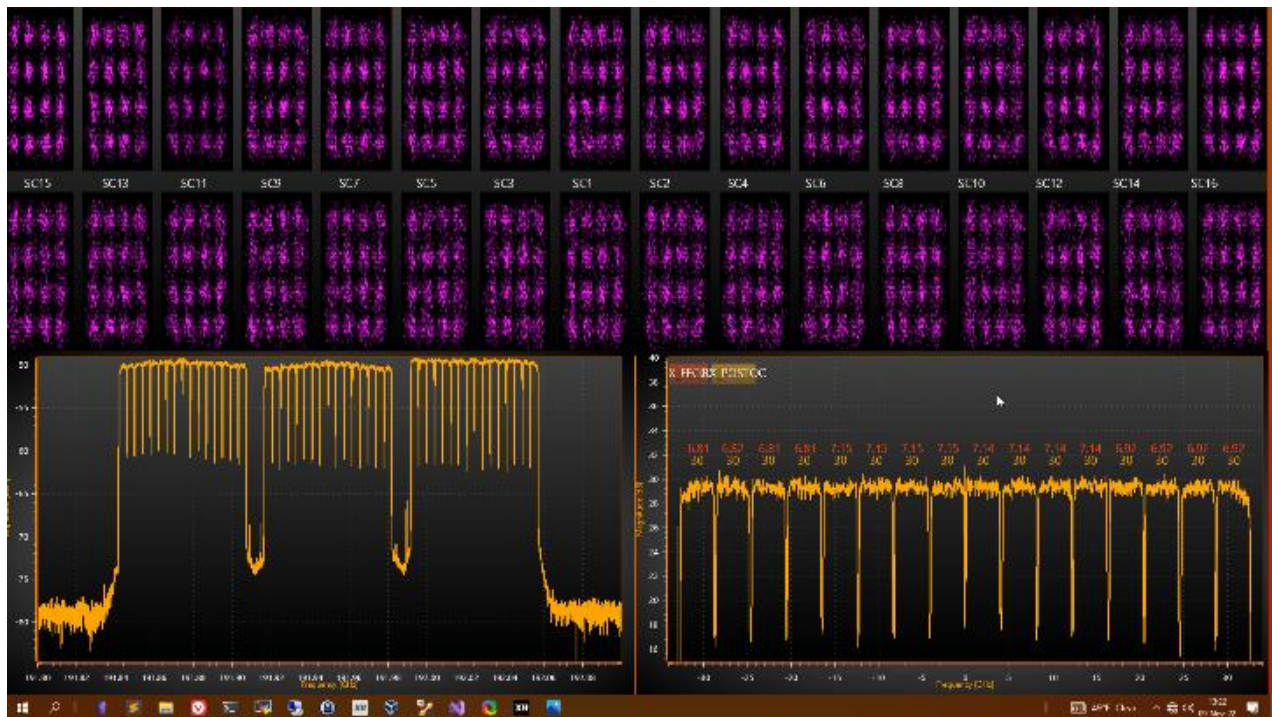

Figure 16: LEAF XR at 191.950THz with aggressors Colorless A/D Spectrum and Per-Subcarrier 16 QAM Constellation Diagram



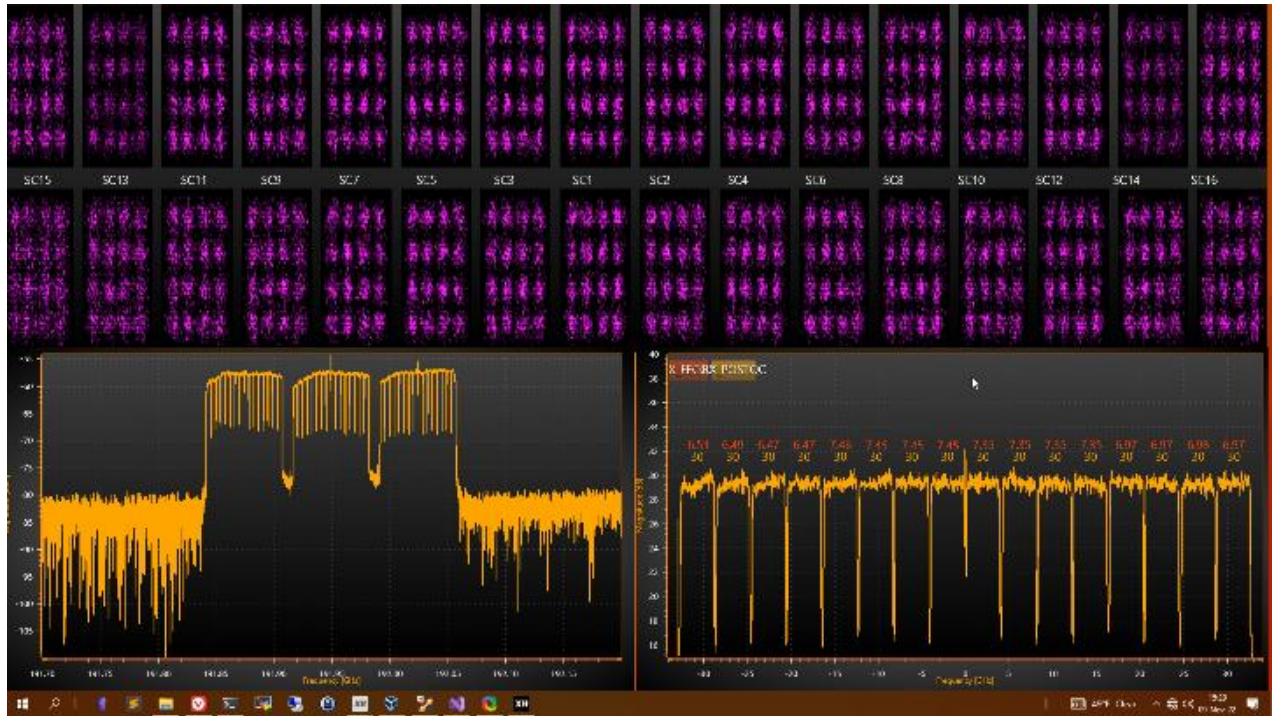

Figure 17: LEAF XR at 191.950THz with aggressors FOADM Spectrum and Per-Subcarrier 16 QAM Constellation Diagram

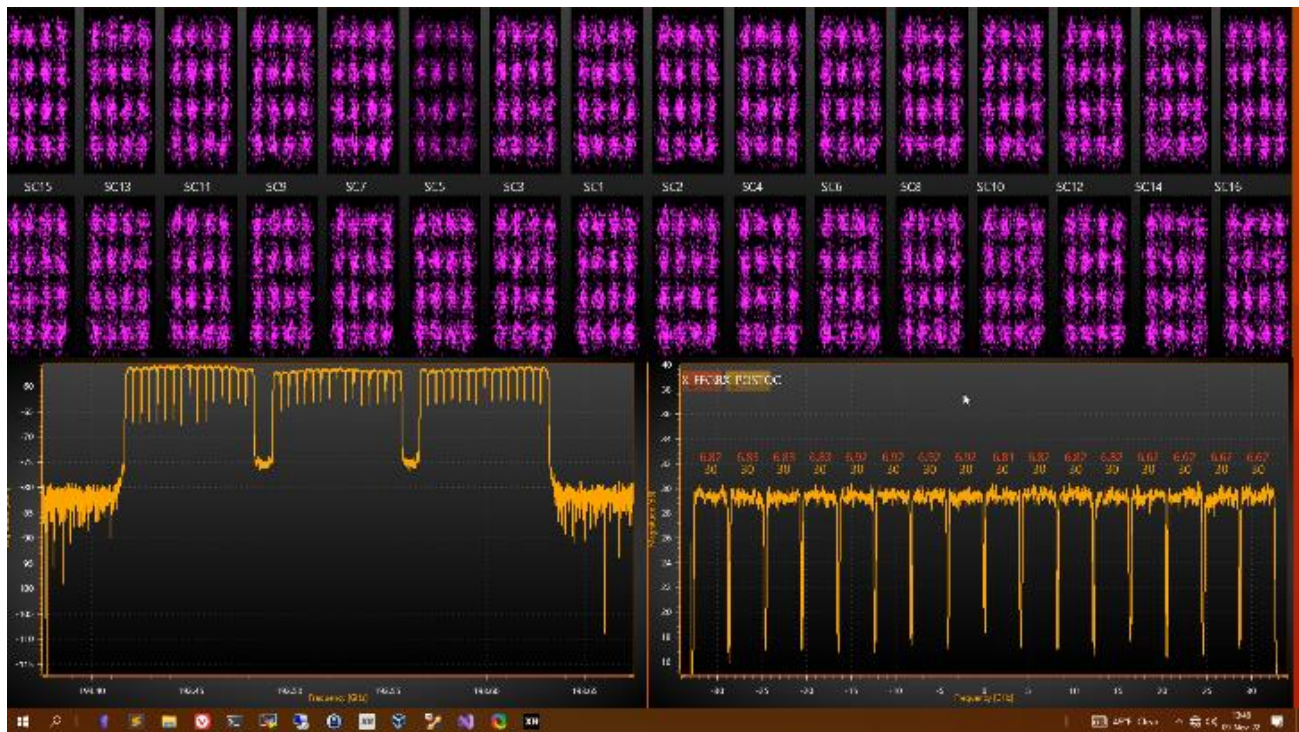

Figure 18: LEAF XR at 193.525THz with aggressors Colorless A/D Spectrum and Per-Subcarrier 16 QAM Constellation Diagram



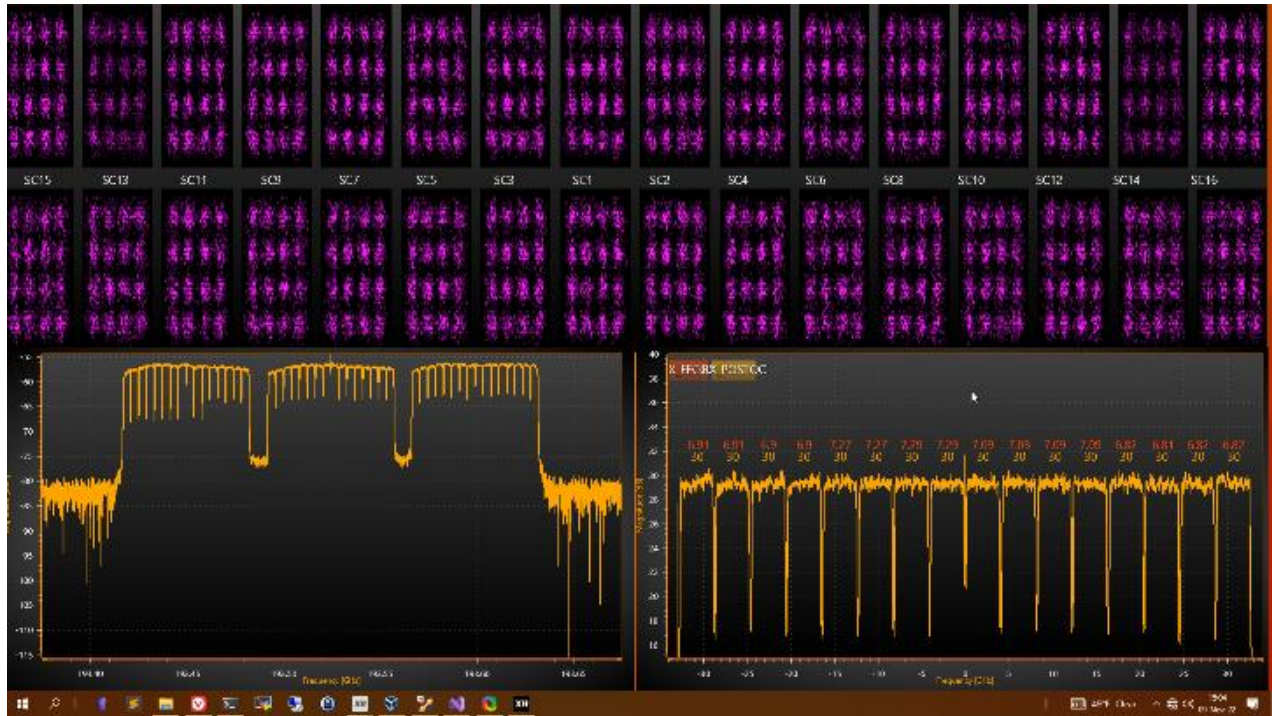

Figure 19: LEAF XR at 193.525THz with aggressors FOADM Spectrum and Per-Subcarrier 16 QAM Constellation Diagram

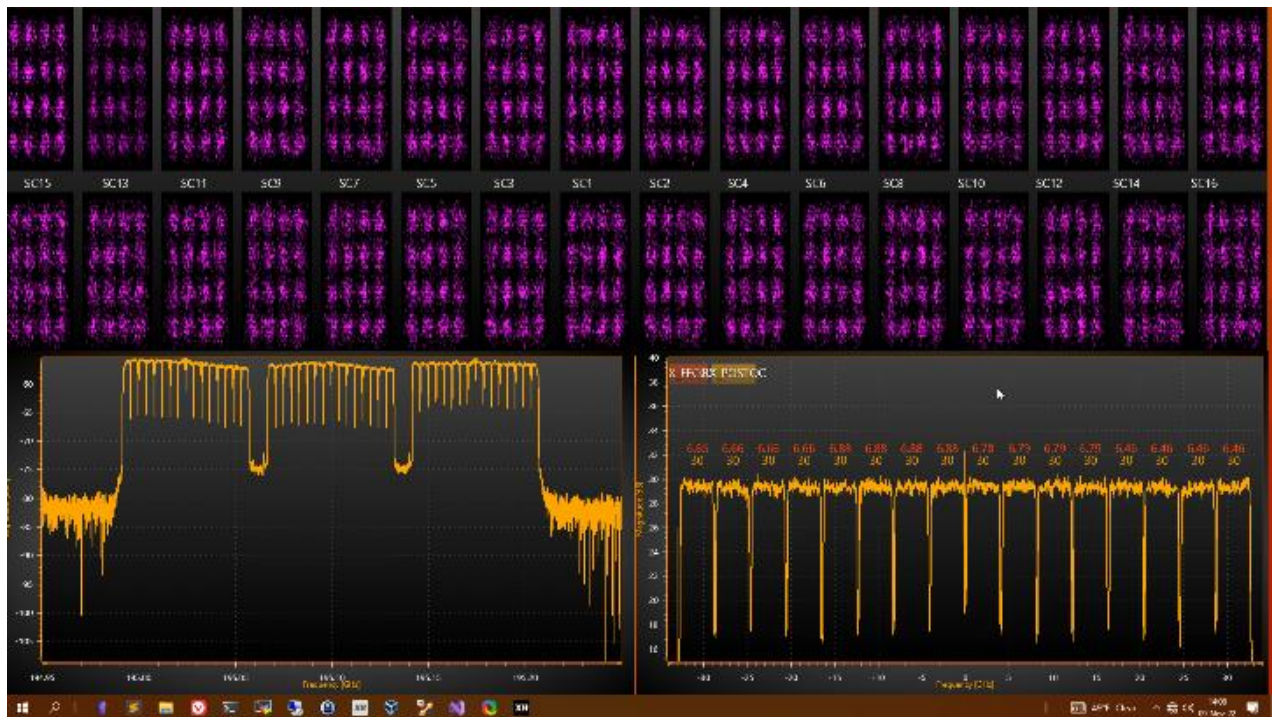

Figure 20: LEAF XR at 195.100THz with aggressors Colorless A/D Spectrum and Per-Subcarrier 16 QAM Constellation Diagram



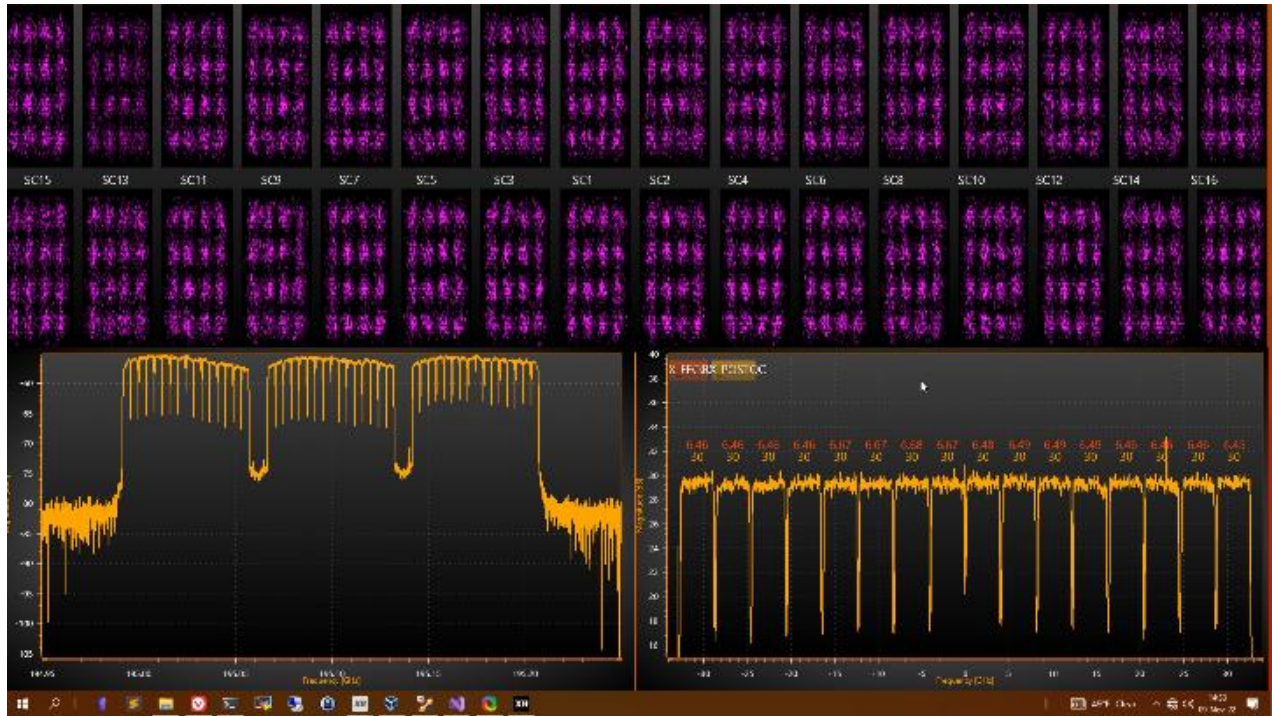

Figure 21: LEAF XR at 195.100THz with aggressors FOADM Spectrum and Per-Subcarrier 16 QAM Constellation Diagram

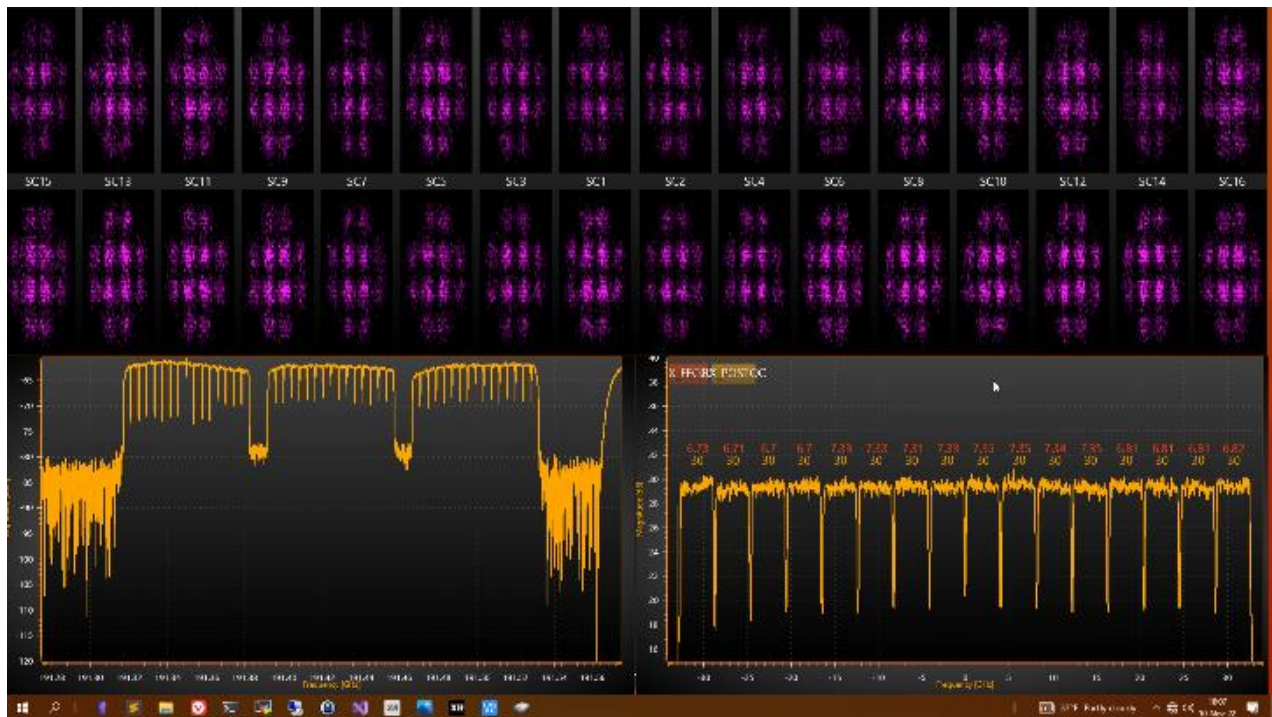

Figure 22: SMF-ULL+LEAF XR at 191.425THz with aggressors FOADM Spectrum and Per-Subcarrier 16 QAM Constellation Diagram

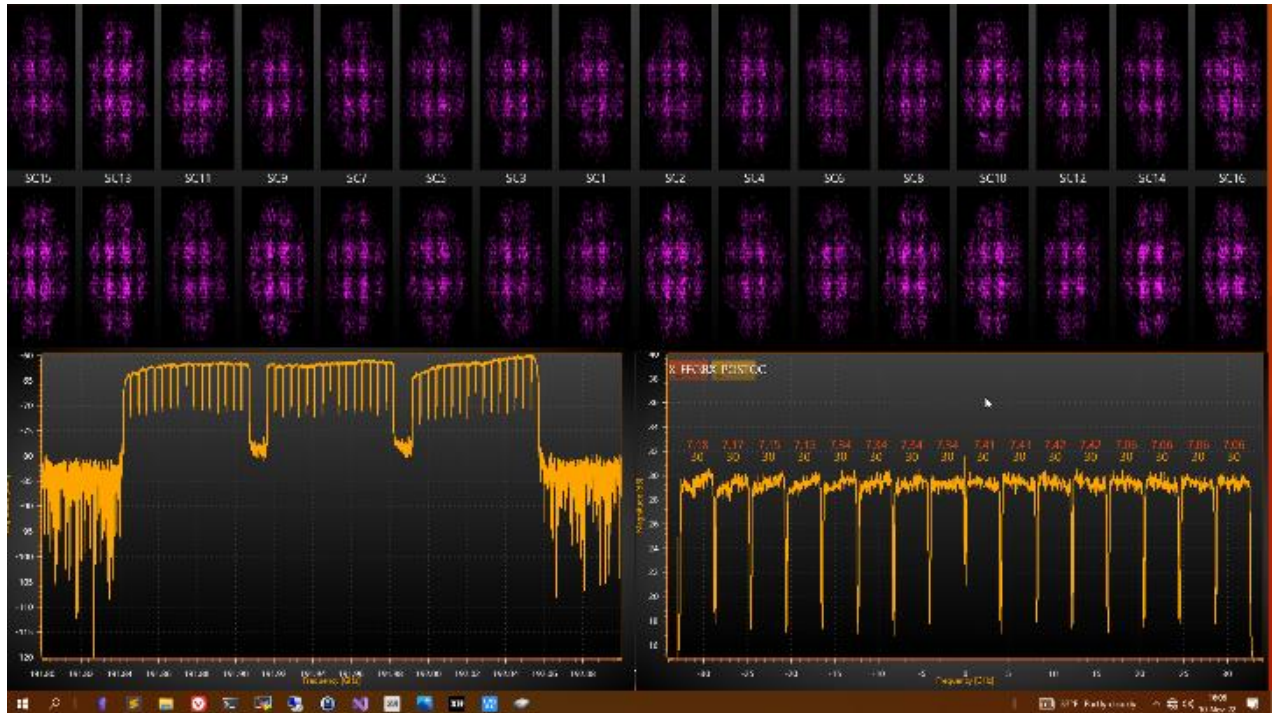

Figure 23: SMF-ULL+LEAF XR at 191.950THz with aggressors FOADM Spectrum and Per-Subcarrier 16 QAM Constellation Diagram

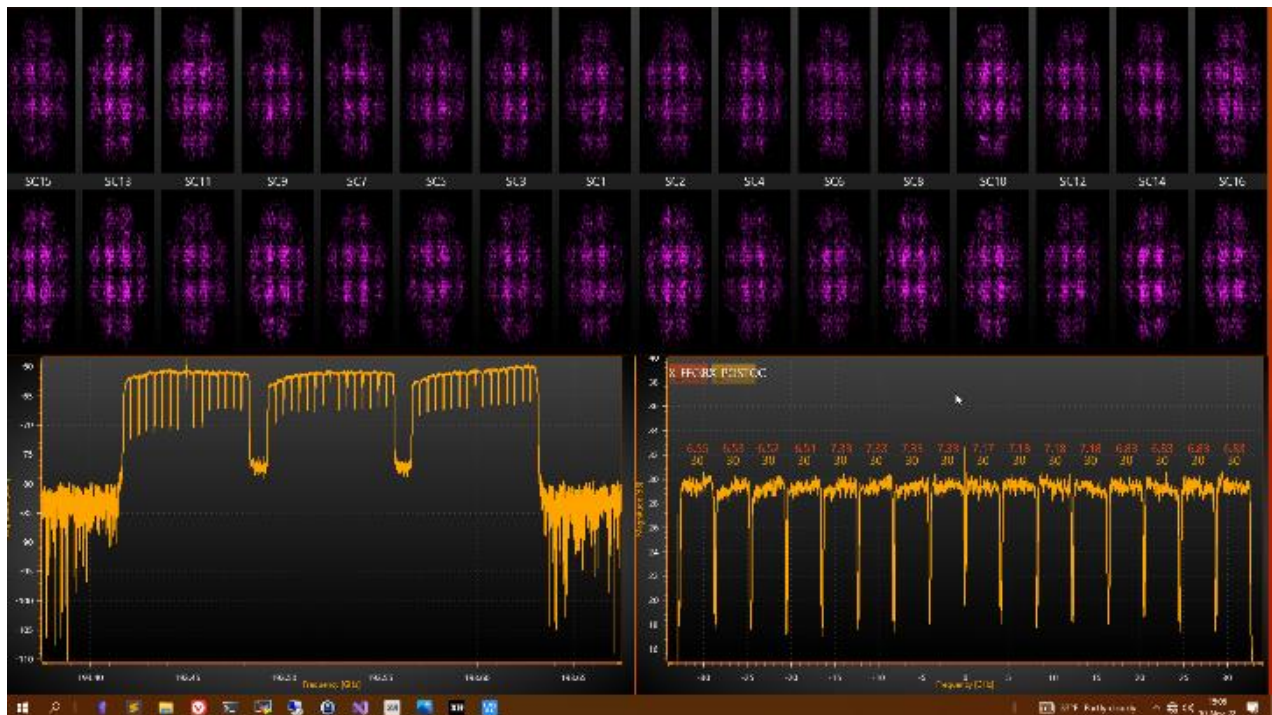

Figure 24: SMF-ULL+LEAF XR at 193.525THz with aggressors FOADM Spectrum and Per-Subcarrier 16 QAM Constellation Diagram



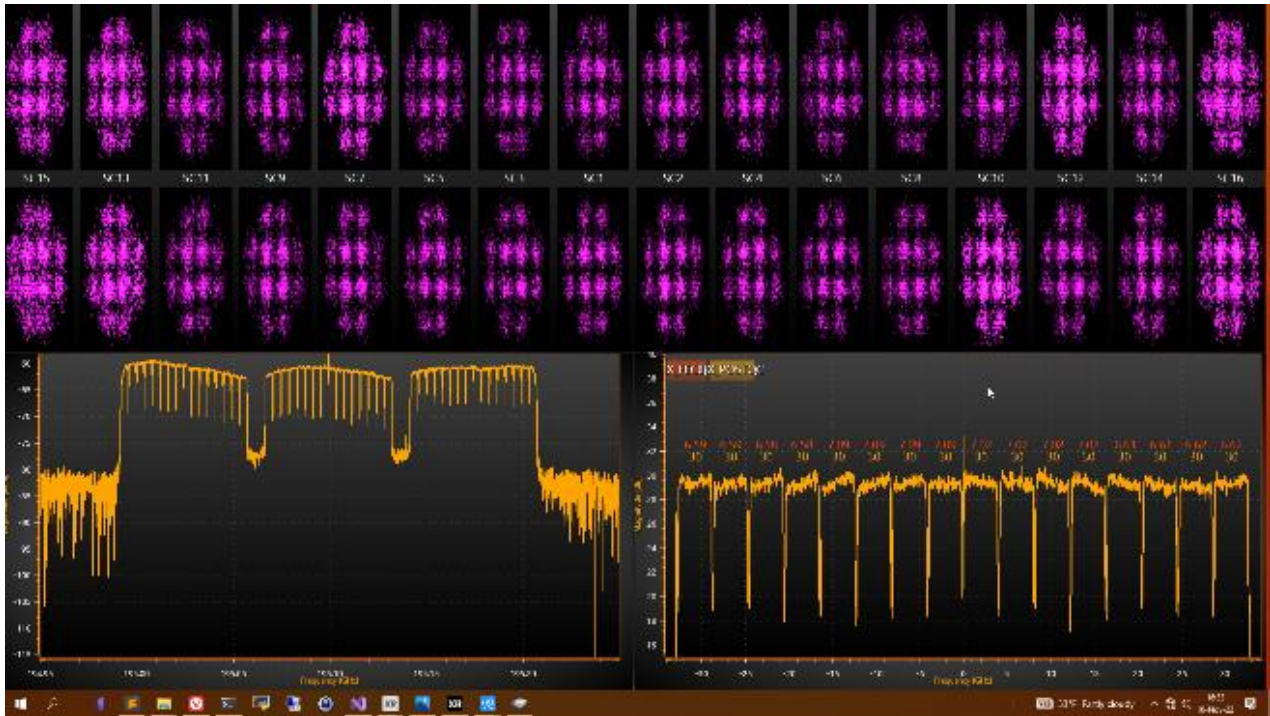

Figure 25: SMF-ULL+LEAF XR at 195.100THz with aggressors FOADM Spectrum and Per-Subcarrier 16 QAM Constellation Diagram